

NO.	REVISION	DATE
1	ISSUED FOR PERMITS	01/21/2022
2	ISSUED FOR CONSTRUCTION	01/21/2022
3	ISSUED FOR CONSTRUCTION	01/21/2022

PROJECT: PY 2020-23
 STANDARD PLANS
 SHEET 1 of 5

GENERAL NOTE:
 1. See Notes 1 through 7.
 2. In untreated areas, all work shall be done in accordance with the Florida Department of Transportation (FDOT) Standard Specifications for Road and Bridge Construction, 2004 Edition, as amended.
 3. All work shall be done in accordance with the Florida Department of Transportation (FDOT) Standard Specifications for Road and Bridge Construction, 2004 Edition, as amended.
 4. All work shall be done in accordance with the Florida Department of Transportation (FDOT) Standard Specifications for Road and Bridge Construction, 2004 Edition, as amended.
 5. All work shall be done in accordance with the Florida Department of Transportation (FDOT) Standard Specifications for Road and Bridge Construction, 2004 Edition, as amended.
 6. All work shall be done in accordance with the Florida Department of Transportation (FDOT) Standard Specifications for Road and Bridge Construction, 2004 Edition, as amended.
 7. All work shall be done in accordance with the Florida Department of Transportation (FDOT) Standard Specifications for Road and Bridge Construction, 2004 Edition, as amended.

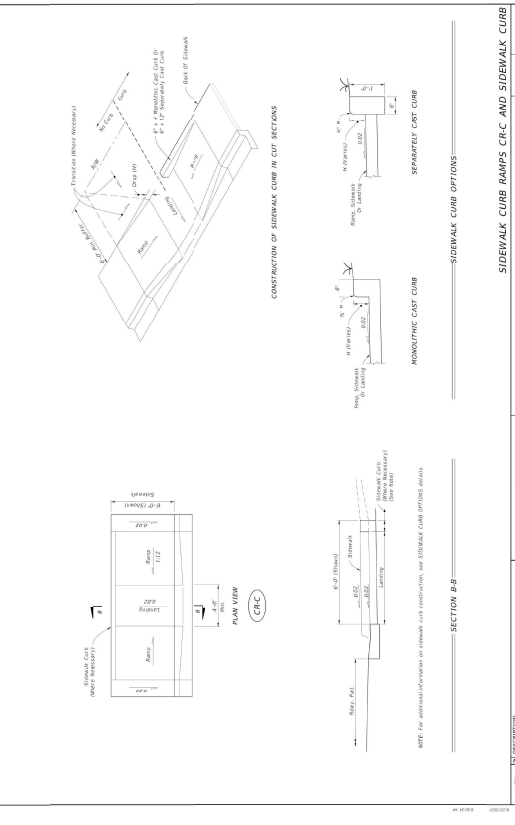

DESCRIPTION: **DETECTABLE WARNING AND SIDEWALK CURB RAMPS**

DATE: **11/01/20**

SCALE: **1" = 12'-0"**

PROJECT: **POINTE GRAND JACKSONVILLE**

DATE: **11/01/20**

SCALE: **1" = 12'-0"**

PROJECT: **POINTE GRAND JACKSONVILLE**

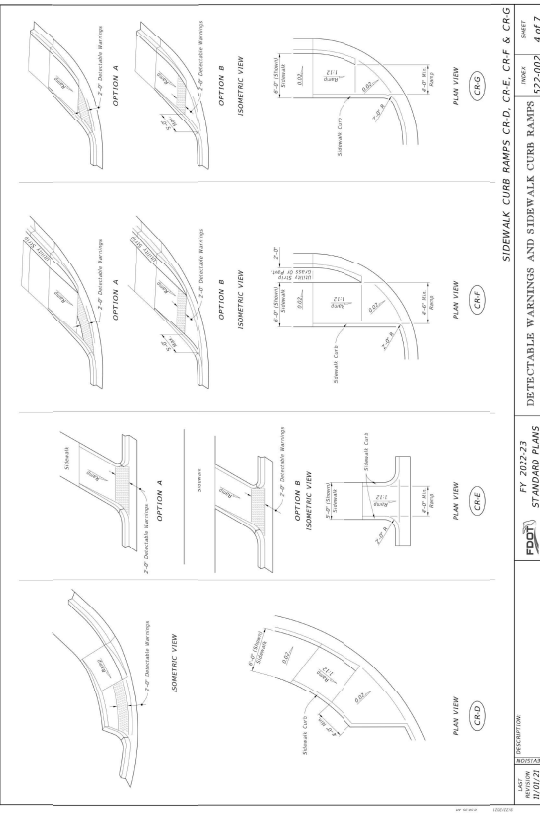

DESCRIPTION: **DETECTABLE WARNING AND SIDEWALK CURB RAMPS**

DATE: **11/01/20**

SCALE: **1" = 12'-0"**

PROJECT: **POINTE GRAND JACKSONVILLE**

DATE: **11/01/20**

SCALE: **1" = 12'-0"**

PROJECT: **POINTE GRAND JACKSONVILLE**

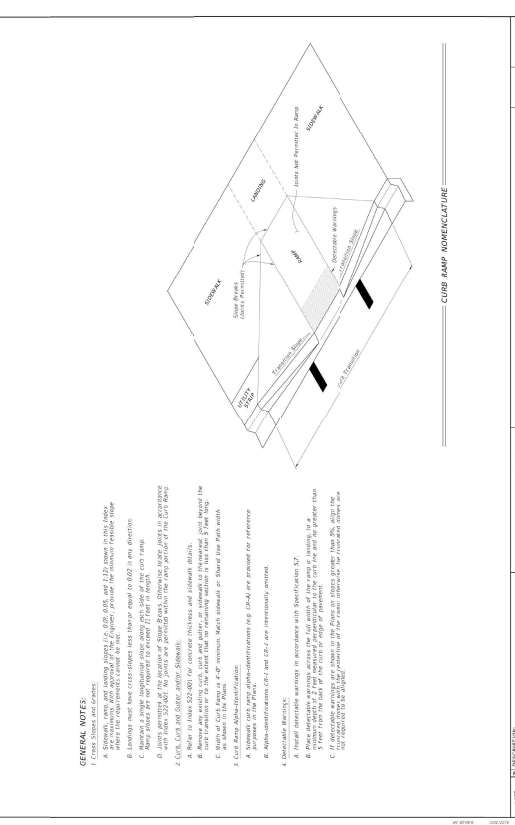

DESCRIPTION: **DETECTABLE WARNING AND SIDEWALK CURB RAMPS**

DATE: **11/01/20**

SCALE: **1" = 12'-0"**

PROJECT: **POINTE GRAND JACKSONVILLE**

DATE: **11/01/20**

SCALE: **1" = 12'-0"**

PROJECT: **POINTE GRAND JACKSONVILLE**

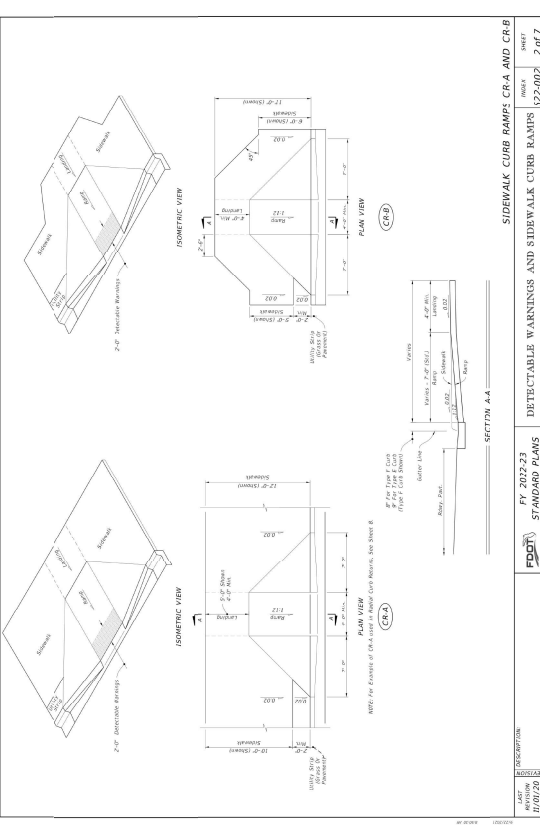

DESCRIPTION: **DETECTABLE WARNING AND SIDEWALK CURB RAMPS**

DATE: **11/01/20**

SCALE: **1" = 12'-0"**

PROJECT: **POINTE GRAND JACKSONVILLE**

DATE: **11/01/20**

SCALE: **1" = 12'-0"**

PROJECT: **POINTE GRAND JACKSONVILLE**

- GENERAL NOTES:**
1. Sidewalk, curbs, and warning ramps shall be constructed in accordance with Florida Building Code, Chapter 6, Part 905, and Florida Building Code, Chapter 6, Part 906, and Florida Building Code, Chapter 6, Part 907, and Florida Building Code, Chapter 6, Part 908, and Florida Building Code, Chapter 6, Part 909, and Florida Building Code, Chapter 6, Part 910, and Florida Building Code, Chapter 6, Part 911, and Florida Building Code, Chapter 6, Part 912, and Florida Building Code, Chapter 6, Part 913, and Florida Building Code, Chapter 6, Part 914, and Florida Building Code, Chapter 6, Part 915, and Florida Building Code, Chapter 6, Part 916, and Florida Building Code, Chapter 6, Part 917, and Florida Building Code, Chapter 6, Part 918, and Florida Building Code, Chapter 6, Part 919, and Florida Building Code, Chapter 6, Part 920, and Florida Building Code, Chapter 6, Part 921, and Florida Building Code, Chapter 6, Part 922, and Florida Building Code, Chapter 6, Part 923, and Florida Building Code, Chapter 6, Part 924, and Florida Building Code, Chapter 6, Part 925, and Florida Building Code, Chapter 6, Part 926, and Florida Building Code, Chapter 6, Part 927, and Florida Building Code, Chapter 6, Part 928, and Florida Building Code, Chapter 6, Part 929, and Florida Building Code, Chapter 6, Part 930, and Florida Building Code, Chapter 6, Part 931, and Florida Building Code, Chapter 6, Part 932, and Florida Building Code, Chapter 6, Part 933, and Florida Building Code, Chapter 6, Part 934, and Florida Building Code, Chapter 6, Part 935, and Florida Building Code, Chapter 6, Part 936, and Florida Building Code, Chapter 6, Part 937, and Florida Building Code, Chapter 6, Part 938, and Florida Building Code, Chapter 6, Part 939, and Florida Building Code, Chapter 6, Part 940, and Florida Building Code, Chapter 6, Part 941, and Florida Building Code, Chapter 6, Part 942, and Florida Building Code, Chapter 6, Part 943, and Florida Building Code, Chapter 6, Part 944, and Florida Building Code, Chapter 6, Part 945, and Florida Building Code, Chapter 6, Part 946, and Florida Building Code, Chapter 6, Part 947, and Florida Building Code, Chapter 6, Part 948, and Florida Building Code, Chapter 6, Part 949, and Florida Building Code, Chapter 6, Part 950, and Florida Building Code, Chapter 6, Part 951, and Florida Building Code, Chapter 6, Part 952, and Florida Building Code, Chapter 6, Part 953, and Florida Building Code, Chapter 6, Part 954, and Florida Building Code, Chapter 6, Part 955, and Florida Building Code, Chapter 6, Part 956, and Florida Building Code, Chapter 6, Part 957, and Florida Building Code, Chapter 6, Part 958, and Florida Building Code, Chapter 6, Part 959, and Florida Building Code, Chapter 6, Part 960, and Florida Building Code, Chapter 6, Part 961, and Florida Building Code, Chapter 6, Part 962, and Florida Building Code, Chapter 6, Part 963, and Florida Building Code, Chapter 6, Part 964, and Florida Building Code, Chapter 6, Part 965, and Florida Building Code, Chapter 6, Part 966, and Florida Building Code, Chapter 6, Part 967, and Florida Building Code, Chapter 6, Part 968, and Florida Building Code, Chapter 6, Part 969, and Florida Building Code, Chapter 6, Part 970, and Florida Building Code, Chapter 6, Part 971, and Florida Building Code, Chapter 6, Part 972, and Florida Building Code, Chapter 6, Part 973, and Florida Building Code, Chapter 6, Part 974, and Florida Building Code, Chapter 6, Part 975, and Florida Building Code, Chapter 6, Part 976, and Florida Building Code, Chapter 6, Part 977, and Florida Building Code, Chapter 6, Part 978, and Florida Building Code, Chapter 6, Part 979, and Florida Building Code, Chapter 6, Part 980, and Florida Building Code, Chapter 6, Part 981, and Florida Building Code, Chapter 6, Part 982, and Florida Building Code, Chapter 6, Part 983, and Florida Building Code, Chapter 6, Part 984, and Florida Building Code, Chapter 6, Part 985, and Florida Building Code, Chapter 6, Part 986, and Florida Building Code, Chapter 6, Part 987, and Florida Building Code, Chapter 6, Part 988, and Florida Building Code, Chapter 6, Part 989, and Florida Building Code, Chapter 6, Part 990, and Florida Building Code, Chapter 6, Part 991, and Florida Building Code, Chapter 6, Part 992, and Florida Building Code, Chapter 6, Part 993, and Florida Building Code, Chapter 6, Part 994, and Florida Building Code, Chapter 6, Part 995, and Florida Building Code, Chapter 6, Part 996, and Florida Building Code, Chapter 6, Part 997, and Florida Building Code, Chapter 6, Part 998, and Florida Building Code, Chapter 6, Part 999, and Florida Building Code, Chapter 6, Part 1000.

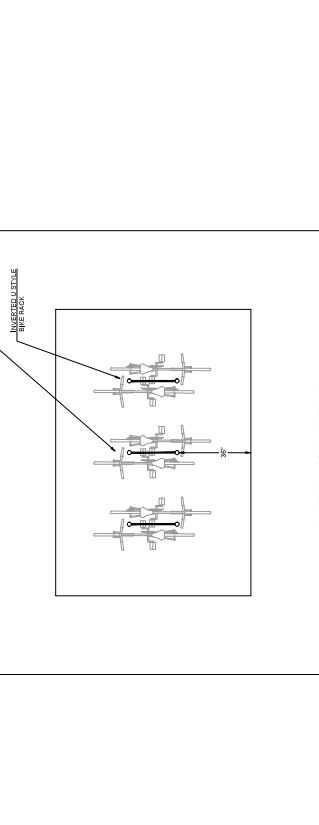
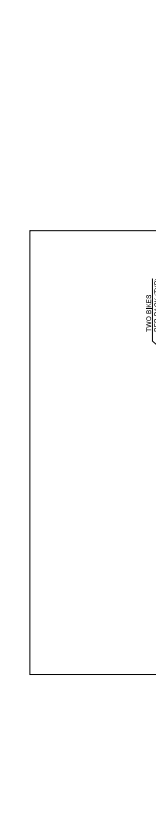
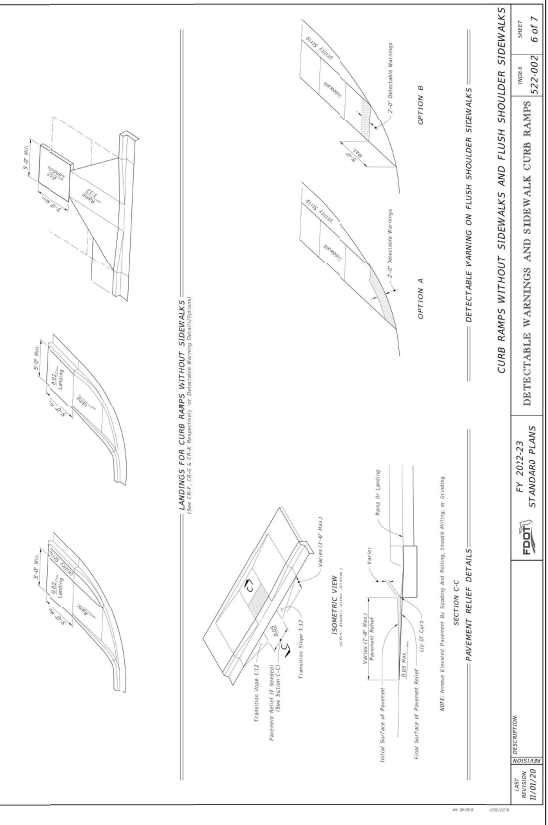

NO.	DESCRIPTION	DATE
1	ISSUED FOR PERMITS	01/21/22
2	ISSUED FOR A.A. REVIEW	01/21/22
3	ISSUED FOR A.A. REVIEW	01/21/22

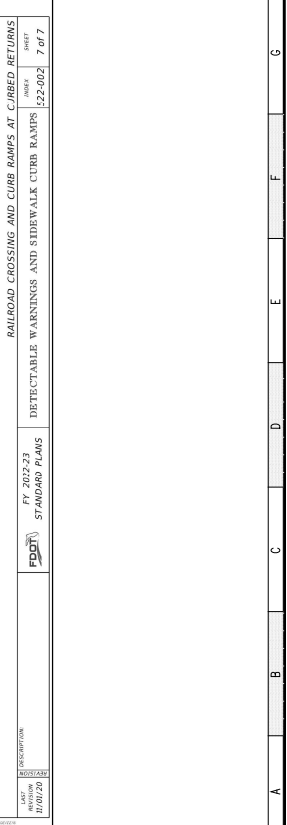
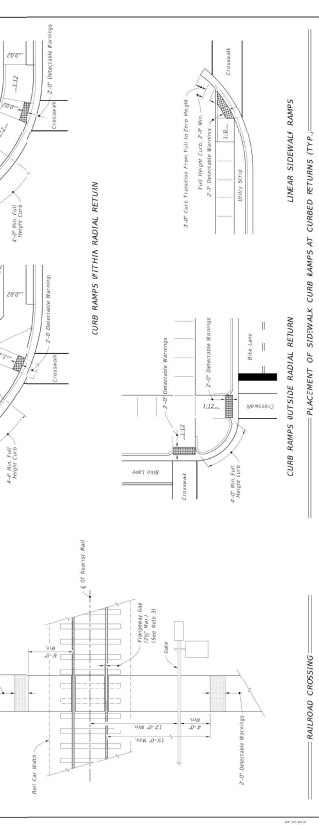
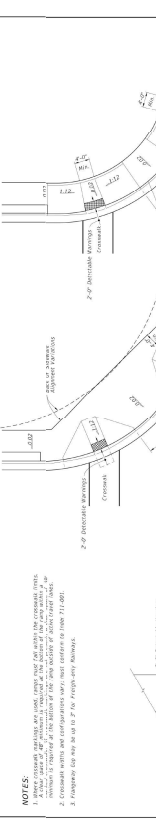
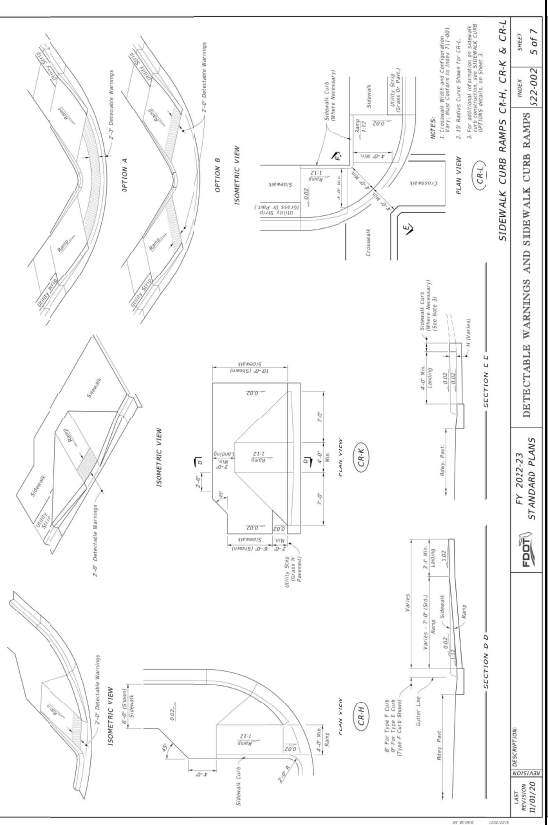



DRAWING DATE: JANUARY 21, 2022

SHEET REVISIONS

NO.	DESCRIPTION	DATE
1	ISSUED FOR PERMITS	01/21/2022
2	ISSUED FOR PERMITS	01/21/2022

